

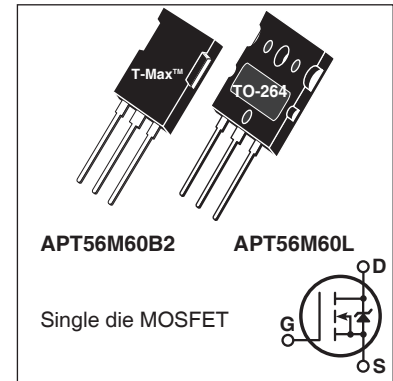

## N-Channel MOSFET

Power MOS 8™ is a high speed, high voltage N-channel switch-mode power MOSFET. A proprietary planar stripe design yields excellent reliability and manufacturability. Low switching loss is achieved with low input capacitance and ultra low  $C_{rss}$  "Miller" capacitance. The intrinsic gate resistance and capacitance of the poly-silicon gate structure help control slew rates during switching, resulting in low EMI and reliable paralleling, even when switching at very high frequency. Reliability in flyback, boost, forward, and other circuits is enhanced by the high avalanche energy capability.



### FEATURES

- Fast switching with low EMI/RFI
- Low  $R_{DS(on)}$
- Ultra low  $C_{rss}$  for improved noise immunity
- Low gate charge
- Avalanche energy rated
- RoHS compliant 

### TYPICAL APPLICATIONS

- PFC and other boost converter
- Buck converter
- Two switch forward (asymmetrical bridge)
- Single switch forward
- Flyback
- Inverters

### Absolute Maximum Ratings

| Symbol   | Parameter  | Ratings | Unit |
|----------|--|---------|------|
| $I_D$    | Continuous Drain Current @ $T_C = 25^\circ\text{C}$  | 56      | A    |
|          | Continuous Drain Current @ $T_C = 100^\circ\text{C}$ | 35      |      |
| $I_{DM}$ | Pulsed Drain Current <sup>①</sup>                    | 210     |      |
| $V_{GS}$ | Gate-Source Voltage                                  | ±30     | V    |
| $E_{AS}$ | Single Pulse Avalanche Energy <sup>②</sup>           | 1580    | mJ   |
| $I_{AR}$ | Avalanche Current, Repetitive or Non-Repetitive      | 28      | A    |

### Thermal and Mechanical Characteristics

| Symbol          | Characteristic   | Min | Typ  | Max  | Unit   |
|-----------------|--|-----|------|------|--------|
| $P_D$           | Total Power Dissipation @ $T_C = 25^\circ\text{C}$     |     |      | 1040 | W      |
| $R_{\theta JC}$ | Junction to Case Thermal Resistance                    |     |      | 0.12 | °C/W   |
| $R_{\theta CS}$ | Case to Sink Thermal Resistance, Flat, Greased Surface |     | 0.11 |      |        |
| $T_J, T_{STG}$  | Operating and Storage Junction Temperature Range       | -55 |      | 150  | °C     |
| $T_L$           | Soldering Temperature for 10 Seconds (1.6mm from case) |     |      | 300  |        |
| $W_T$           | Package Weight   |     | 0.22 |      | oz     |
|                 |  |     | 6.2  |      | g      |
| Torque          | Mounting Torque ( TO-264 Package), 4-40 or M3 screw    |     |      | 10   | in-lbf |
|                 |  |     |      | 1.1  | N-m    |

**Static Characteristics**
**T<sub>J</sub> = 25°C unless otherwise specified**
**APT56M60B2\_L**

| Symbol                                 | Parameter                                 | Test Conditions  | Min | Typ  | Max  | Unit  |
|--|---|--|-----|------|------|-------|
| V <sub>BR(DSS)</sub>                   | Drain-Source Breakdown Voltage            | V <sub>GS</sub> = 0V, I <sub>D</sub> = 250μA               | 600 |      |      | V     |
| ΔV <sub>BR(DSS)</sub> /ΔT <sub>J</sub> | Breakdown Voltage Temperature Coefficient | Reference to 25°C, I <sub>D</sub> = 250μA                  |     | 0.57 |      | V/°C  |
| R <sub>DS(on)</sub>                    | Drain-Source On Resistance <sup>③</sup>   | V <sub>GS</sub> = 10V, I <sub>D</sub> = 28A                |     | 0.11 | 0.13 | Ω     |
| V <sub>GS(th)</sub>                    | Gate-Source Threshold Voltage             | V <sub>GS</sub> = V <sub>DS</sub> , I <sub>D</sub> = 2.5mA | 3   | 4    | 5    | V     |
| ΔV <sub>GS(th)</sub> /ΔT <sub>J</sub>  | Threshold Voltage Temperature Coefficient |  |     | -10  |      | mV/°C |
| I <sub>DSS</sub>                       | Zero Gate Voltage Drain Current           | V <sub>DS</sub> = 600V<br>V <sub>GS</sub> = 0V             |     |      | 25   | μA    |
|  |   | T <sub>J</sub> = 25°C<br>T <sub>J</sub> = 125°C            |     |      | 500  |       |
| I <sub>GSS</sub>                       | Gate-Source Leakage Current               | V <sub>GS</sub> = ±30V                                     |     |      | ±100 | nA    |

**Dynamic Characteristics**
**T<sub>J</sub> = 25°C unless otherwise specified**

| Symbol                          | Parameter                                    | Test Conditions  | Min | Typ   | Max | Unit |
|---------------------------------|--|--|-----|-------|-----|------|
| g <sub>fs</sub>                 | Forward Transconductance                     | V <sub>DS</sub> = 50V, I <sub>D</sub> = 28A  |     | 55    |     | S    |
| C <sub>iss</sub>                | Input Capacitance                            | V <sub>GS</sub> = 0V, V <sub>DS</sub> = 25V<br>f = 1MHz  |     | 11300 |     | pF   |
| C <sub>rss</sub>                | Reverse Transfer Capacitance                 |  |     | 115   |     |      |
| C <sub>oss</sub>                | Output Capacitance                           |  |     | 1040  |     |      |
| C <sub>o(cr)</sub> <sup>④</sup> | Effective Output Capacitance, Charge Related | V <sub>GS</sub> = 0V, V <sub>DS</sub> = 0V to 400V   |     | 550   |     | pF   |
| C <sub>o(er)</sub> <sup>⑤</sup> | Effective Output Capacitance, Energy Related |  |     | 285   |     |      |
| Q <sub>g</sub>                  | Total Gate Charge                            | V <sub>GS</sub> = 0 to 10V, I <sub>D</sub> = 28A,<br>V <sub>DS</sub> = 300V  |     | 280   |     | nC   |
| Q <sub>gs</sub>                 | Gate-Source Charge                           |  |     | 60    |     |      |
| Q <sub>gd</sub>                 | Gate-Drain Charge                            |  |     | 120   |     |      |
| t <sub>d(on)</sub>              | Turn-On Delay Time                           | <b>Resistive Switching</b><br>V <sub>DD</sub> = 400V, I <sub>D</sub> = 28A<br>R <sub>G</sub> = 2.2Ω <sup>⑥</sup> , V <sub>GG</sub> = 15V |     | 65    |     | ns   |
| t <sub>r</sub>                  | Current Rise Time                            |  |     | 75    |     |      |
| t <sub>d(off)</sub>             | Turn-Off Delay Time                          |  |     | 190   |     |      |
| t <sub>f</sub>                  | Current Fall Time                            |  |     | 60    |     |      |

**Source-Drain Diode Characteristics**

| Symbol          | Parameter                                       | Test Conditions   | Min | Typ | Max | Unit |
|-----------------|---|---|-----|-----|-----|------|
| I <sub>S</sub>  | Continuous Source Current (Body Diode)          | MOSFET symbol showing the integral reverse p-n junction diode (body diode)              |     |     | 56  | A    |
| I <sub>SM</sub> | Pulsed Source Current (Body Diode) <sup>①</sup> |   |     |     | 210 |      |
| V <sub>SD</sub> | Diode Forward Voltage                           | I <sub>SD</sub> = 28A, T <sub>J</sub> = 25°C, V <sub>GS</sub> = 0V                      |     |     | 1.0 | V    |
| t <sub>rr</sub> | Reverse Recovery Time                           | I <sub>SD</sub> = 28A <sup>②</sup>  |     | 745 |     | ns   |
| Q <sub>rr</sub> | Reverse Recovery Charge                         | di <sub>SD</sub> /dt = 100A/μs, T <sub>J</sub> = 25°C                                   |     | 19  |     | μC   |
| dv/dt           | Peak Recovery dv/dt                             | I <sub>SD</sub> ≤ 28A, di/dt ≤ 1000A/μs, V <sub>DD</sub> = 100V, T <sub>J</sub> = 125°C |     |     | 8   | V/ns |

① Repetitive Rating: Pulse width and case temperature limited by maximum junction temperature.

② Starting at T<sub>J</sub> = 25°C, L = 4.03mH, R<sub>G</sub> = 2.2Ω, I<sub>AS</sub> = 28A.

③ Pulse test: Pulse Width < 380μs, duty cycle < 2%.

④ C<sub>o(cr)</sub> is defined as a fixed capacitance with the same stored charge as C<sub>OSS</sub> with V<sub>DS</sub> = 67% of V<sub>(BR)DSS</sub>.

⑤ C<sub>o(er)</sub> is defined as a fixed capacitance with the same stored energy as C<sub>OSS</sub> with V<sub>DS</sub> = 67% of V<sub>(BR)DSS</sub>. To calculate C<sub>o(er)</sub> for any value of V<sub>DS</sub> less than V<sub>(BR)DSS</sub>, use this equation: C<sub>o(er)</sub> = -1.10E-7/V<sub>DS</sub><sup>2</sup> + 4.60E-8/V<sub>DS</sub> + 1.72E-10.

⑥ R<sub>G</sub> is external gate resistance, not including internal gate resistance or gate driver impedance. (MIC4452)

Microsemi reserves the right to change, without notice, the specifications and information contained herein.

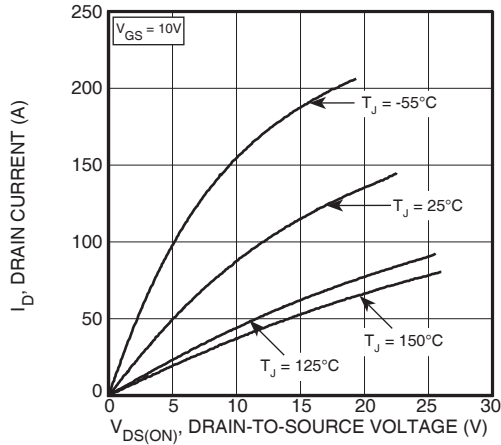

Figure 1, Output Characteristics

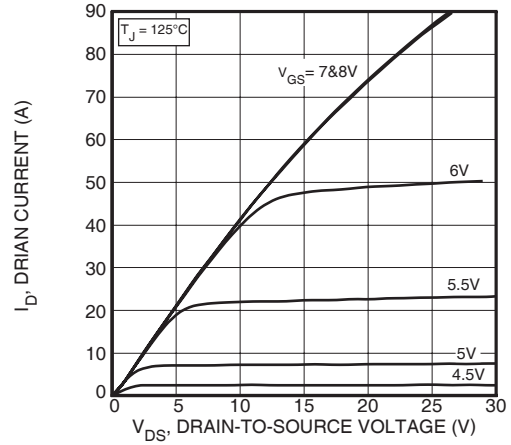

Figure 2, Output Characteristics

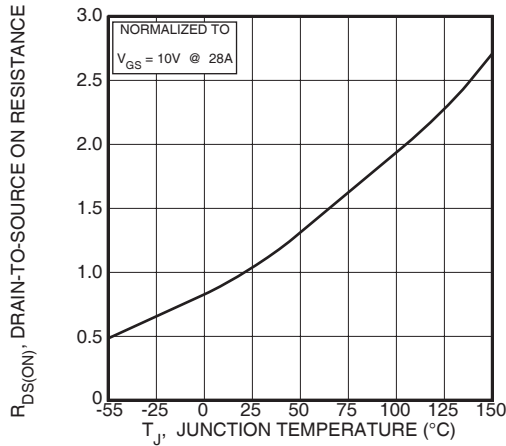

Figure 3,  $R_{DS(ON)}$  vs Junction Temperature

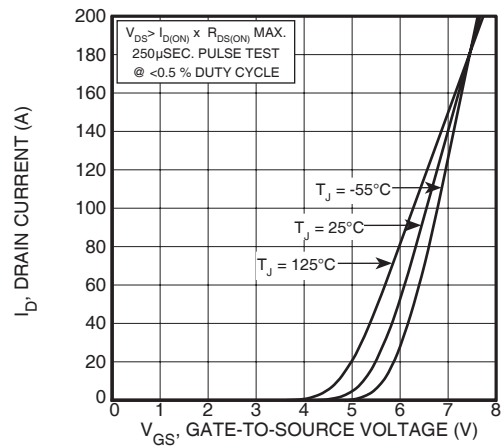

Figure 4, Transfer Characteristics

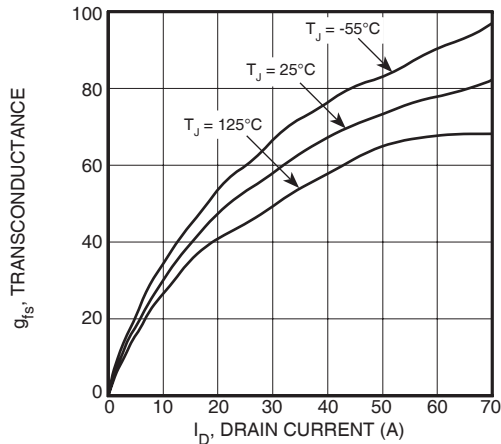

Figure 5, Gain vs Drain Current

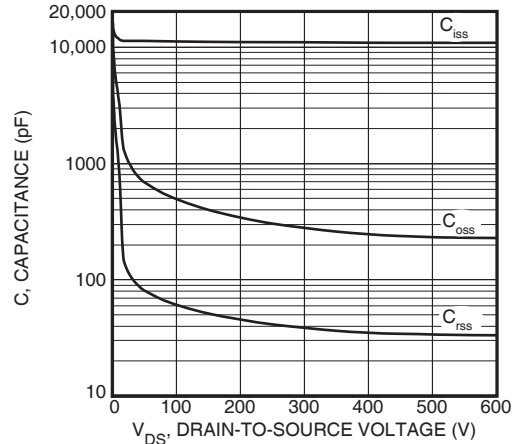

Figure 6, Capacitance vs Drain-to-Source Voltage

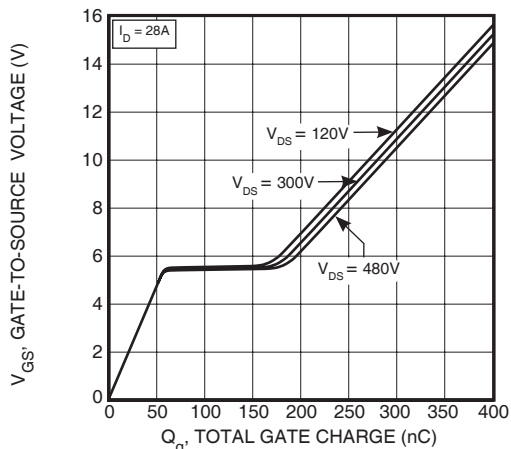

Figure 7, Gate Charge vs Gate-to-Source Voltage

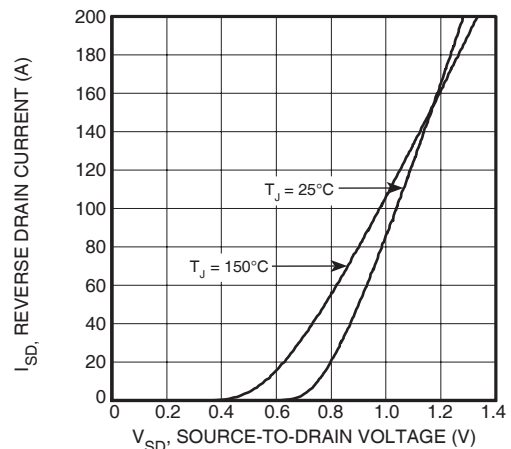
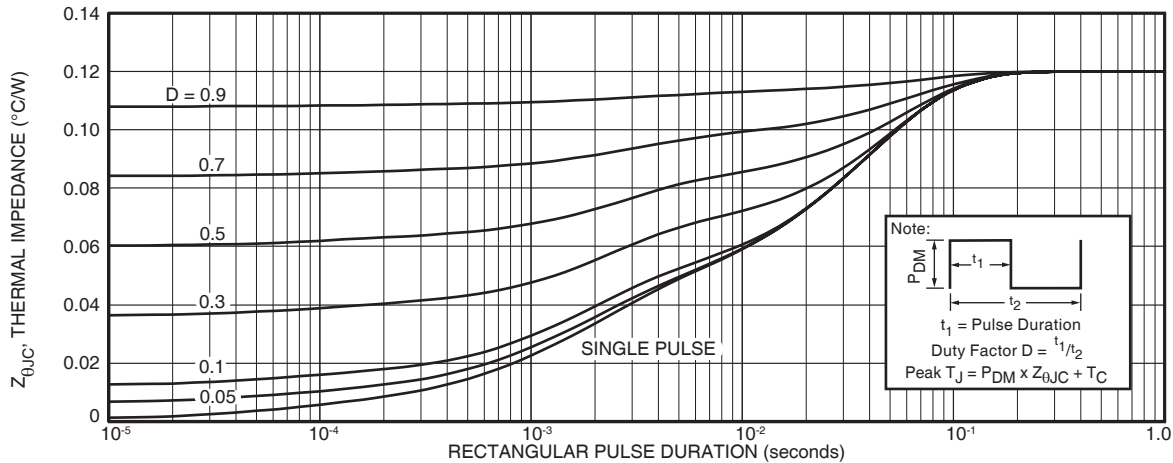
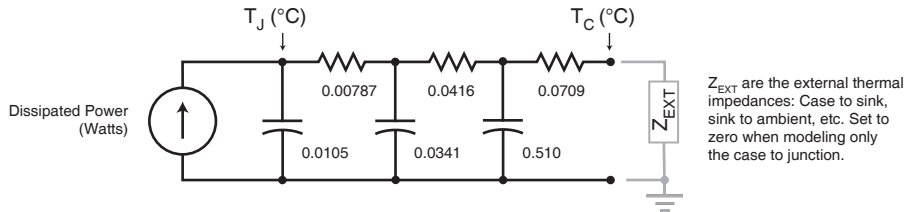
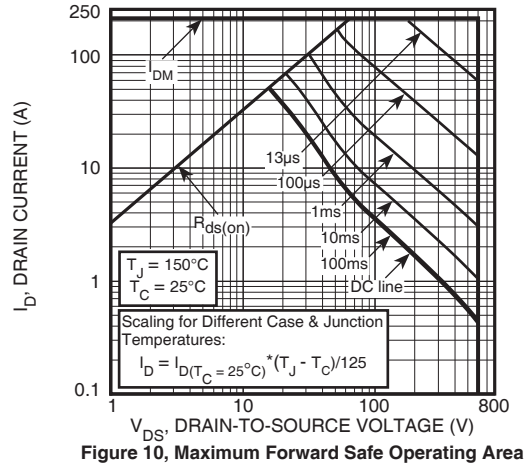
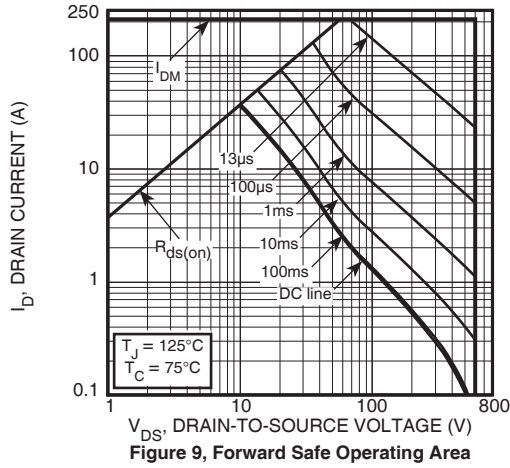

Figure 8, Reverse Drain Current vs Source-to-Drain Voltage



**T-MAX™ (B2) Package Outline**

**TO-264 (L) Package Outline**

